

Universal Group®





The Universal Group Corp 1025 Thomas Busch Memorial Highway  Pennsauken, New Jersey 08110

1120 Eden Road, Suite 100  Arlington, Texas 76001

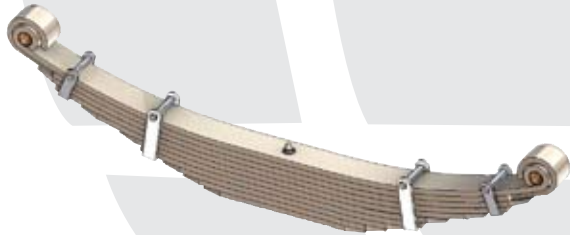
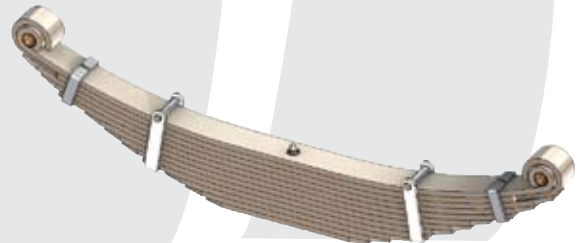
# FWD/Seagrave & HME Springs



NJ Phone: (800) 225-1845  (856) 488-1800  NJ Fax: (800) 360-9636

 TX Phone: (800) 637-4422

# FWD/Seagrave & HME Springs

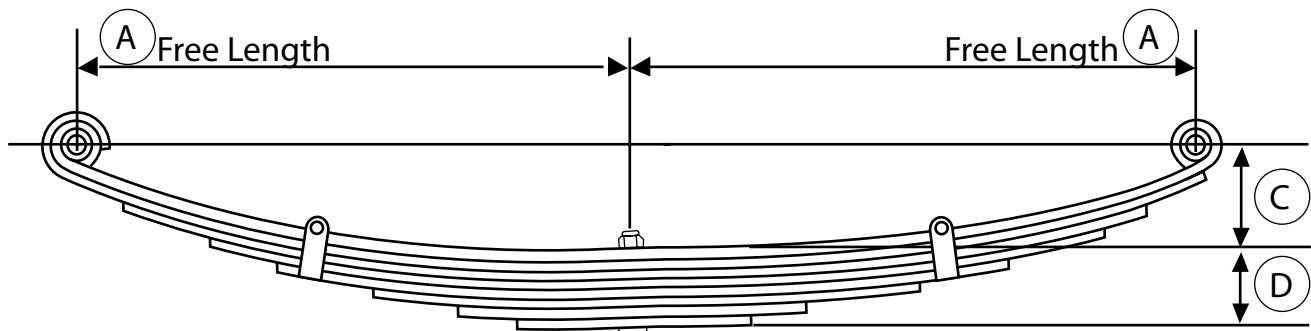

## FWD / Seagrave

Part No.	OEM No.	Width	PL-1	PL-1	Bushing S.E.	Bushing L.E.	Arch (C)	No. Leaves	Grading	Pack Thk. (D)	Spring Capty. At Pad
			S.E. (A)	L.E. (B)							
<b>52" Springs using 1" spring pins</b>											
44-144	151857	3	26 1/8	26 1/8	NJG	NJG	5	10	10/499	5	7,800
<b>52" Springs using 1 1/8" spring pins</b>											
44-117	152255	3	26	26	PLG	PLG	4 1/4	12	12/558	6 11/16	12,000

## HME (Hendrickson Mobile Equipment)

Part No.	OEM No.	Width	PL-1	PL-1	Bushing S.E.	Bushing L.E.	Arch (C)	No. Leaves	Grading	Pack Thk. (D)	Spring Capty. At Pad
			S.E. (A)	L.E. (B)							
<b>52" Springs using 1" spring pins</b>											
50-122	76134	3 1/2	26 1/4	26 1/4	NJI	NJI	4 5/16	9/SE	9/499 SE/499	5	8,500
50-124	82701	3 1/2	26 1/4	26 1/4	NJI	NJI	4 3/16	8/SE	8/558 SE/558	6 11/16	9,500

Any reference to OEM names, part numbers, model numbers or description is for identification only and does not indicate that it is an OEM part.